

SLIDEHIDE Track and Accessories for sliding doors

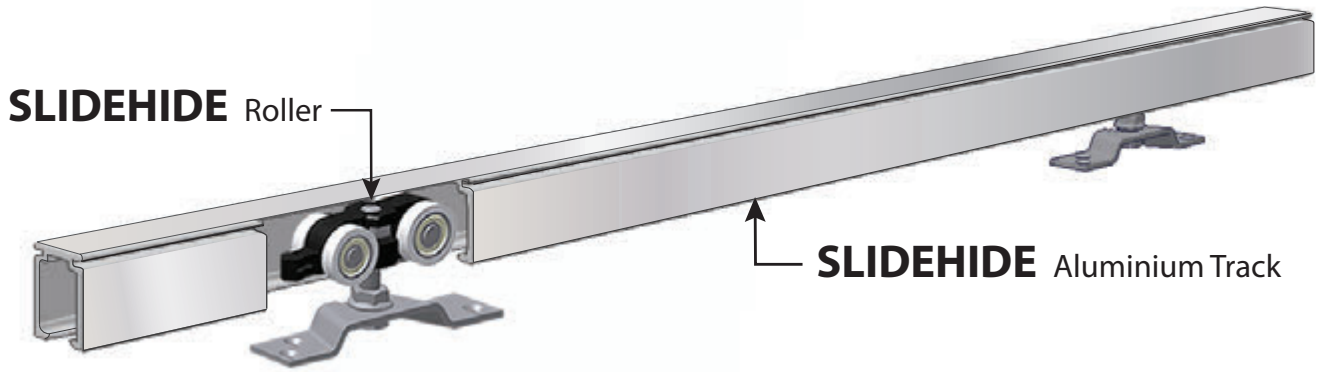

1D1T-UL

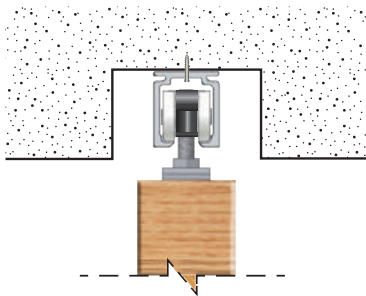

2DDT-UL

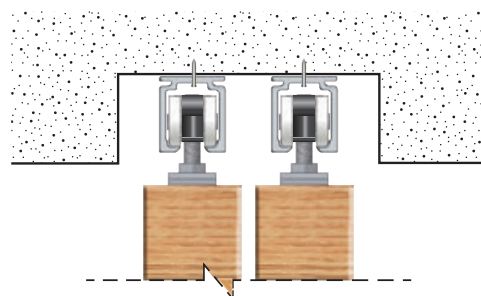

1D1T-F-UL

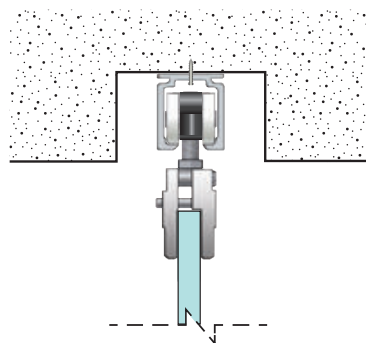

2DDT-F-UL

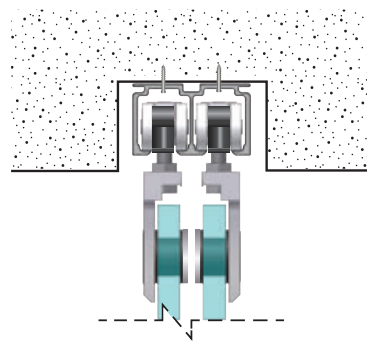

1D1T-WM

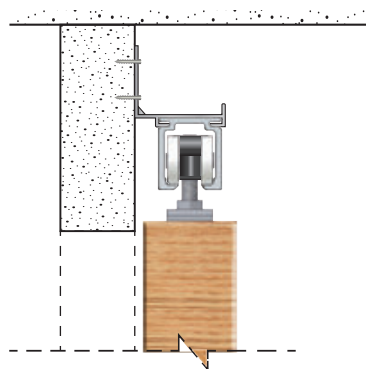

1D1T-F-WM

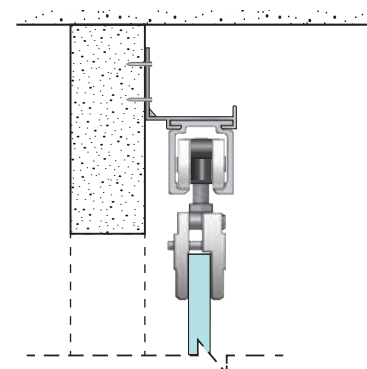

SLIDE & HIDE System (S) Pte Ltd

11, Yishun Industrial Street 1, #07-99, North Spring Bizhub. Singapore 768089

Contact Us :-

Tel : +65 6369 9988

For Email : enquiry@slidehide.com.sg

Fax : +65 6369 9977

For Feedback : cust-svc@slidehide.com.sg

Website : www.slidehide.com.sg



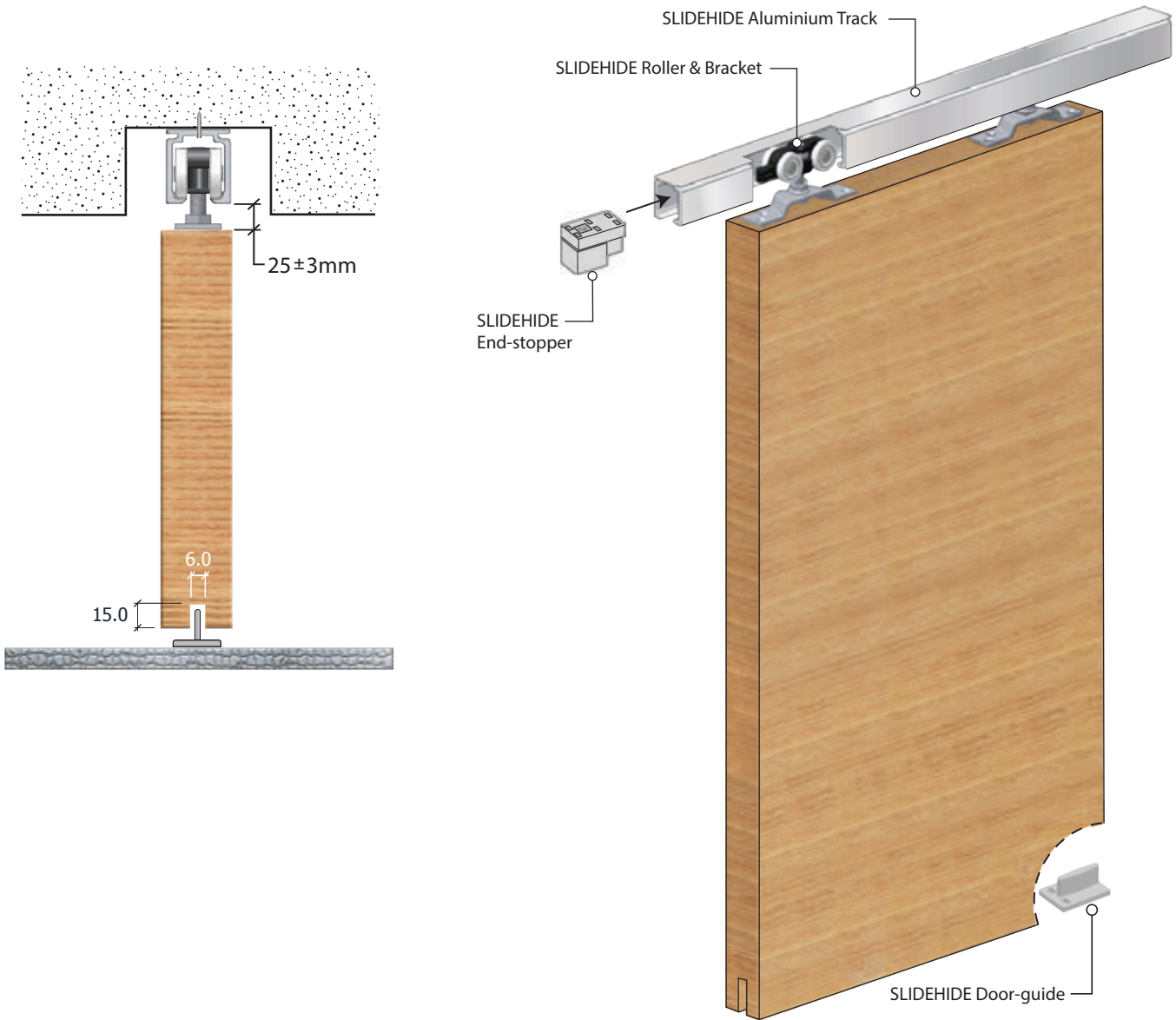

MODEL	MAX DOOR WEIGHT (kg)	LENGTH OF TRACK (mm)		
		2000	3000	4000
1D1T-UL80	80	2000	3000	4000
1D1T-UL120	120	2000	3000	4000

STANDARD ACCESSORIES

<p>Track</p> <p>SLIDEHIDE aluminium track.</p>	<p>Roller & Bracket</p> <p>SLIDEHIDE Roller and steel Hanging-bracket. Test report is available.</p>	<p>End-stopper</p> <p>SLIDEHIDE End-stopper for positioning and preventing door panel from jumping.</p>	<p>Door-guide</p> <p>SLIDEHIDE Door-guide prevents door panel from wobbling while sliding.</p>
---	---	--	---

SLIDE & HIDE System (S) Pte Ltd

11, Yishun Industrial Street 1, #07-99, North Spring Bizhub. Singapore 768089

Tel: +65 6369 9988

Fax: +65 6369 9977

For Email : enquiry@slidehide.com.sg

For Feedback : cust-svc@slidehide.com.sg

Website : www.slidehide.com.sg

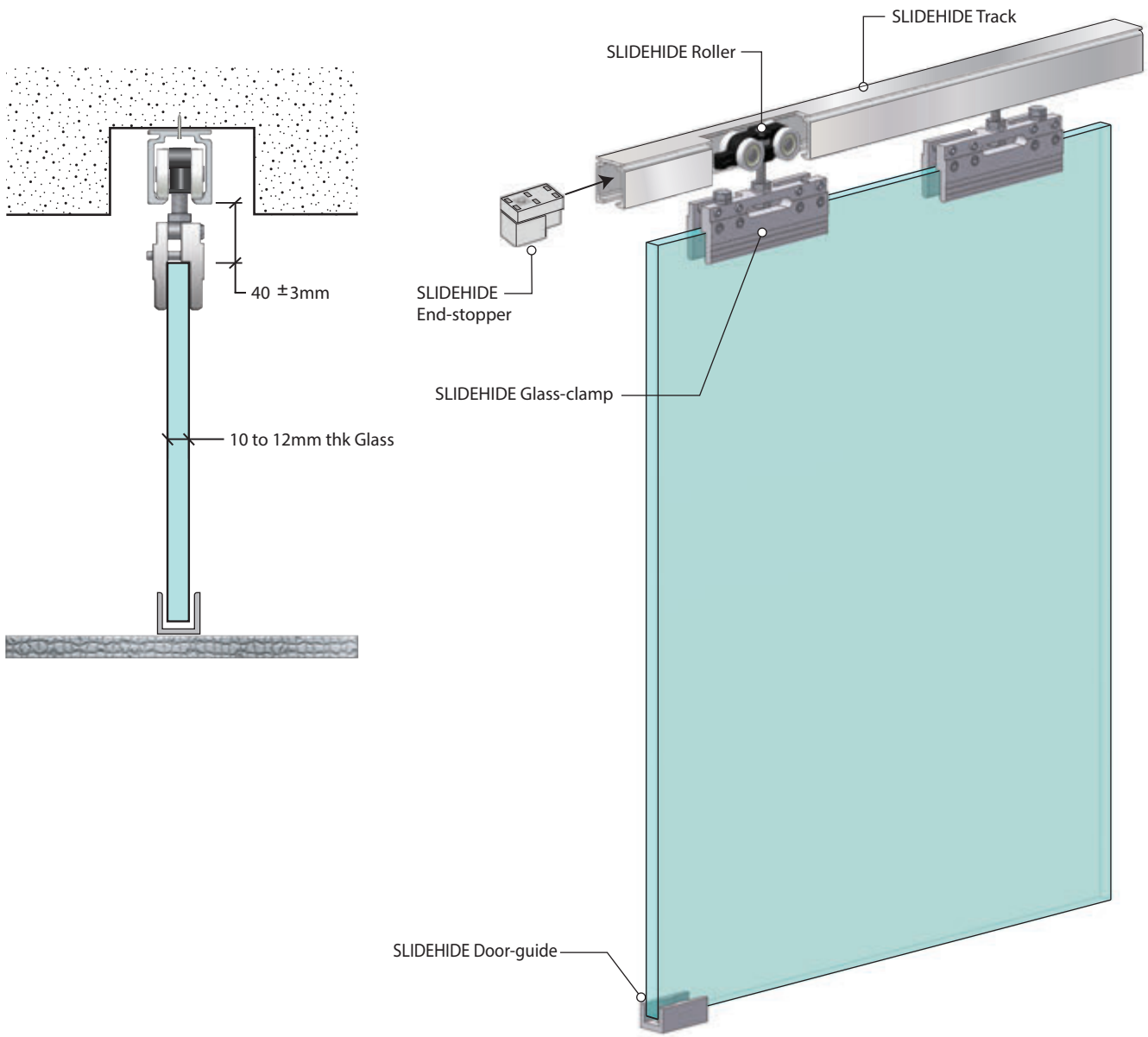

MODEL	MAX DOOR WEIGHT (kg)	LENGTH OF TRACK (mm)		
1D1T-F-UL80	80	2000	3000	4000
1D1T-F-UL120	120	2000	3000	4000

STANDARD ACCESSORIES

<p>Track</p> <p>SLIDEHIDE aluminium track.</p>	<p>Roller & Glass clamp</p> <p>SLIDEHIDE Roller and aluminium Glass clamp. Test report is available.</p>	<p>End-stopper</p> <p>SLIDEHIDE End-stopper for positioning and preventing door panel from jumping.</p>	<p>Door-guide</p> <p>SLIDEHIDE Door-guide prevents door panel from wobbling while sliding.</p>
---	---	--	---

SLIDE & HIDE System (S) Pte Ltd

11, Yishun Industrial Street 1, #07-99, North Spring Bizhub. Singapore 768089

Tel: +65 6369 9988

Fax: +65 6369 9977

For Email: enquiry@slidehide.com.sg

For Feedback: cust-svc@slidehide.com.sg

Website: www.slidehide.com.sg

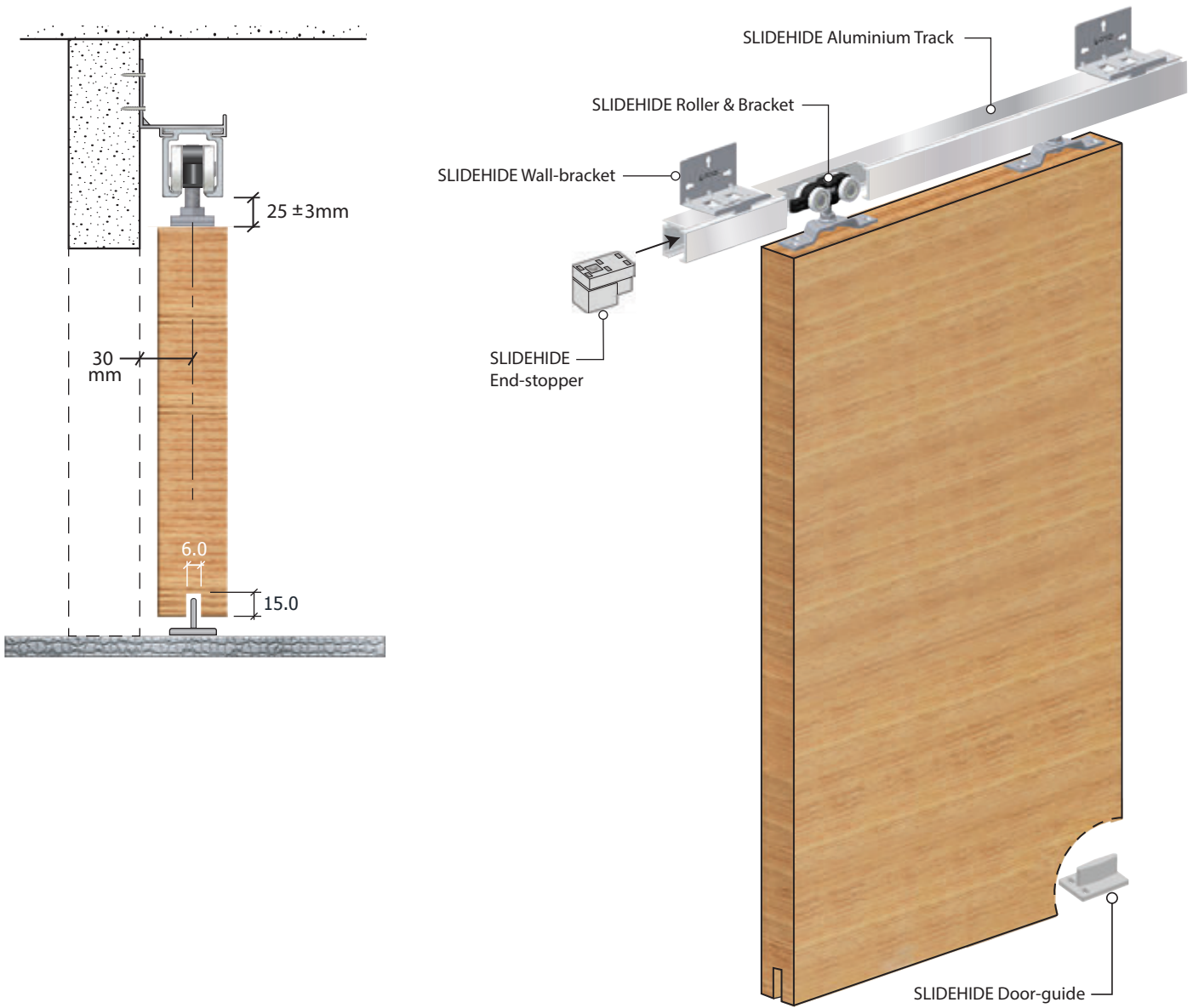

MODEL	MAX DOOR WEIGHT (kg)	LENGTH OF TRACK (mm)		
1D1T-WM80	80	2000	3000	4000
1D1T-WM120	120	2000	3000	4000

STANDARD ACCESSORIES

Track

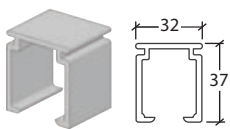

SLIDEHIDE aluminium track.

Roller & Bracket

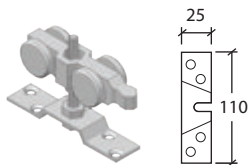

SLIDEHIDE Roller and steel Hanging-bracket. Test report is available.

Wall-bracket

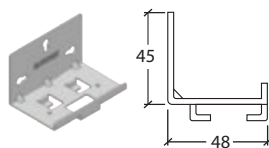

SLIDEHIDE Wall-bracket for mounting track to side of wall.

End-stopper

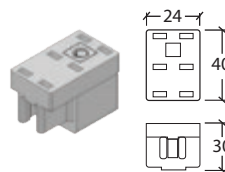

SLIDEHIDE End-stopper for positioning and preventing door panel from jumping.

Door-guide

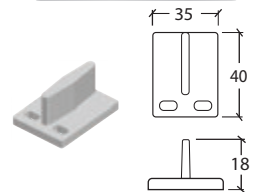

SLIDEHIDE Door-guide prevents door panel from wobbling while sliding.

SLIDE & HIDE System (S) Pte Ltd

11, Yishun Industrial Street 1, #07-99, North Spring Bizhub. Singapore 768089

Tel: +65 6369 9988

Fax: +65 6369 9977

For Email: enquiry@slidehide.com.sg

For Feedback: cust-svc@slidehide.com.sg

Website: www.slidehide.com.sg

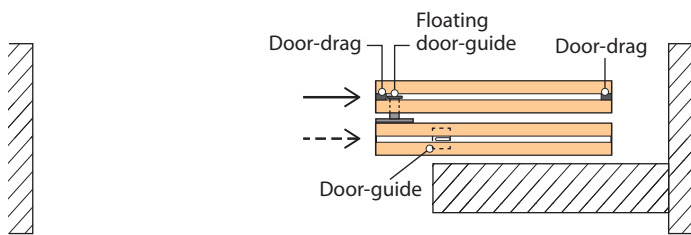
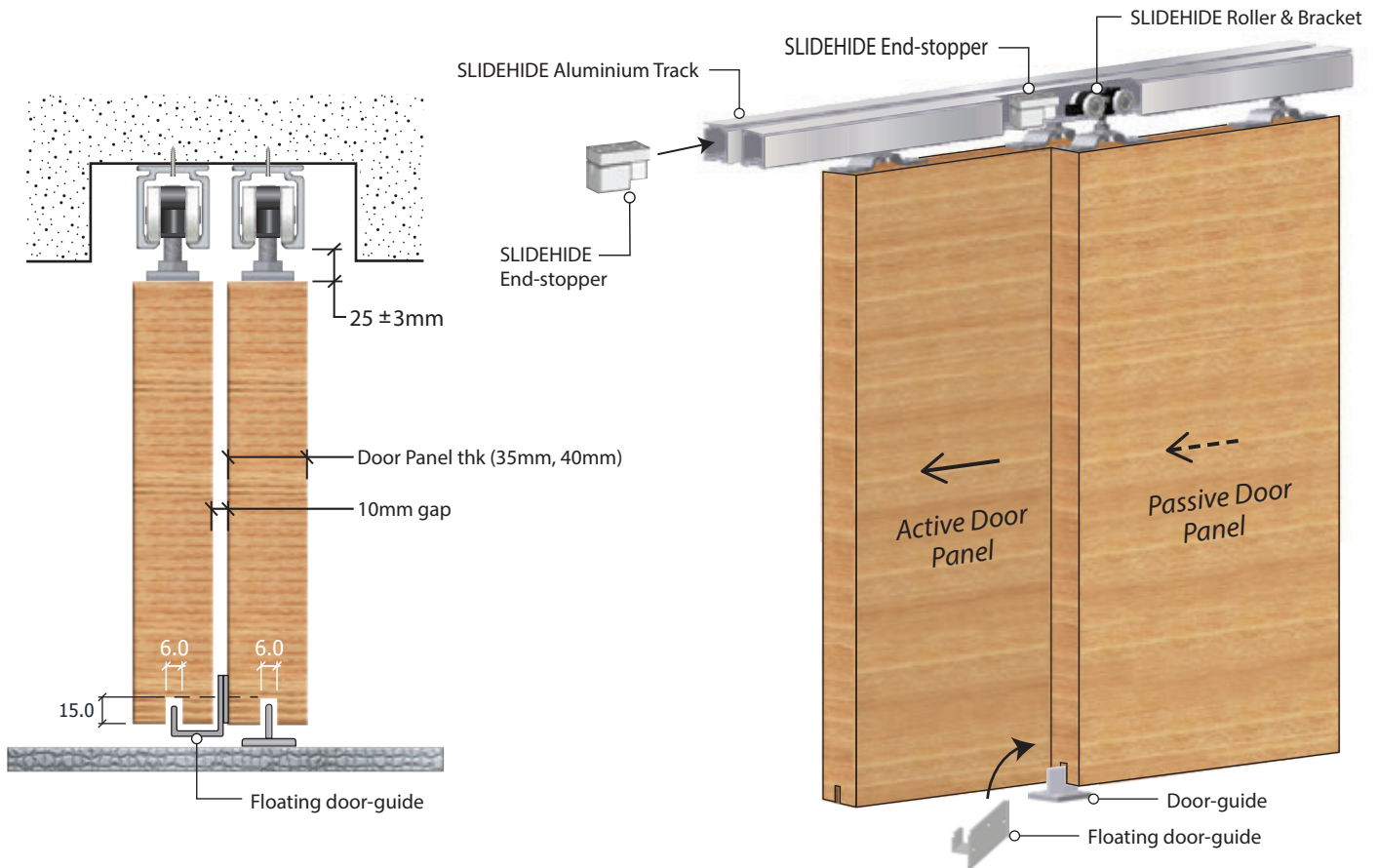

DOOR OPENING

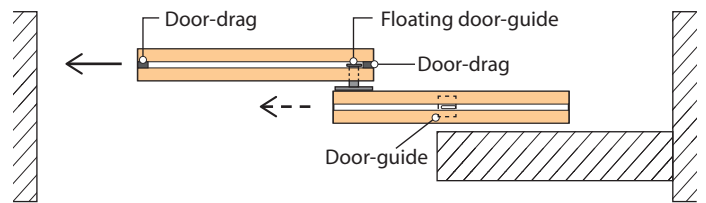

DOOR CLOSING

MODEL	MAX DOOR WEIGHT (kg)	LENGTH OF TRACK (mm)		
		2000	3000	4000
2DDT-UL80	80	2000	3000	4000
2DDT-UL120	120	2000	3000	4000

STANDARD ACCESSORIES

<p>Track</p> <p>SLIDEHIDE aluminium track.</p>	<p>Roller & Bracket</p> <p>SLIDEHIDE Roller and steel Hanging-bracket. Test report is available.</p>	<p>End-stopper</p> <p>SLIDEHIDE End-stopper for positioning and preventing door panel from jumping.</p>	<p>Door-drag</p> <p>SLIDEHIDE Door-drag.</p>	<p>Door-guide</p> <p>SLIDEHIDE Door-guide and Floating door-guide prevents door panel from wobbling while sliding.</p>	<p>Floating door-guide</p> <p>SLIDEHIDE Door-guide and Floating door-guide prevents door panel from wobbling while sliding.</p>
---	---	--	---	---	--

SLIDE & HIDE System (S) Pte Ltd

11, Yishun Industrial Street 1, #07-99, North Spring Bizhub. Singapore 768089

Tel: +65 6369 9988

Fax: +65 6369 9977

For Email : enquiry@slidehide.com.sg

For Feedback : cust-svc@slidehide.com.sg

Website : www.slidehide.com.sg

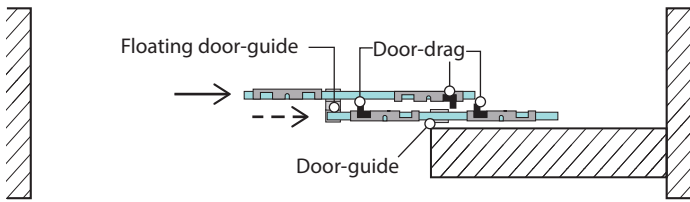
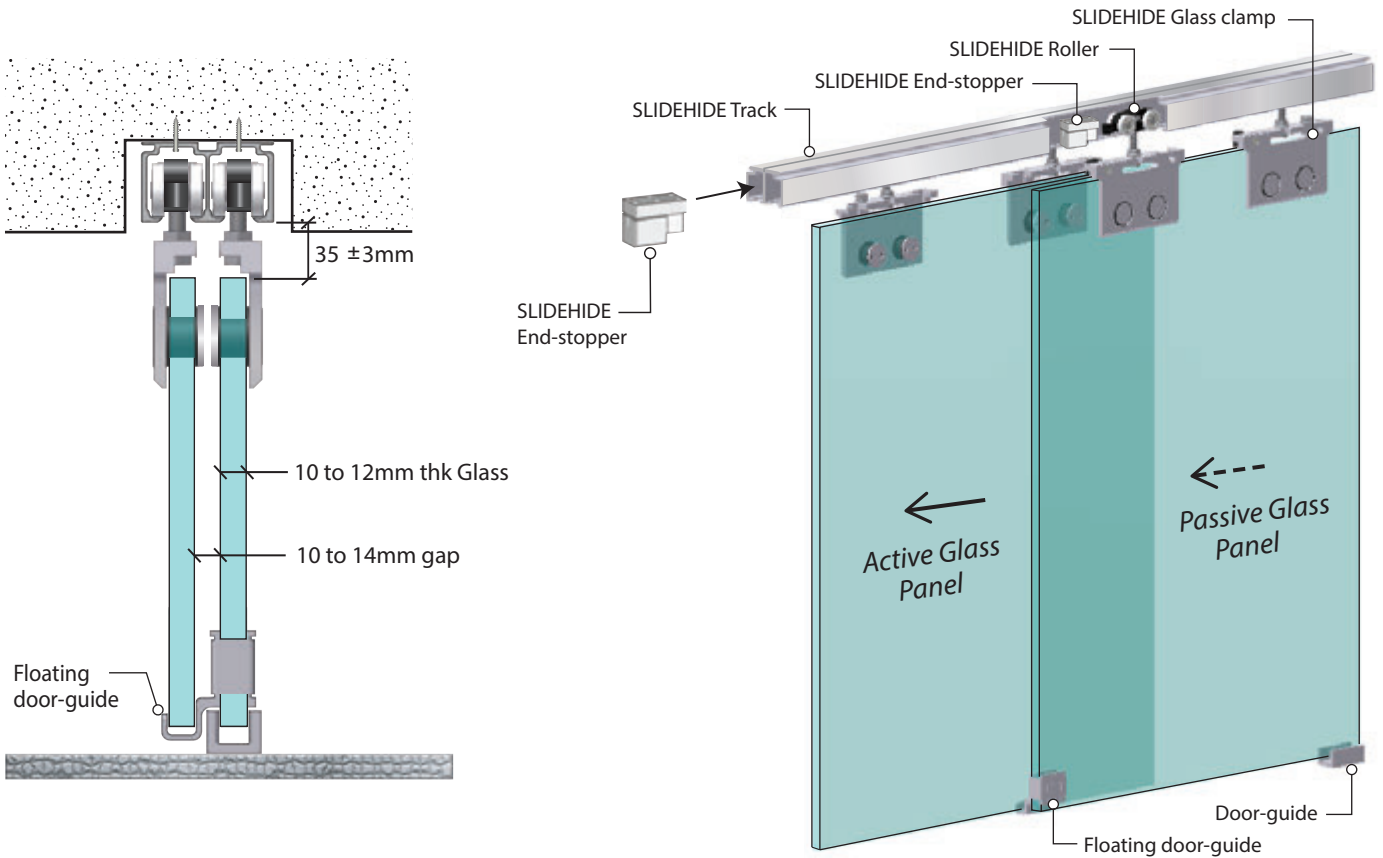

DOOR OPENING

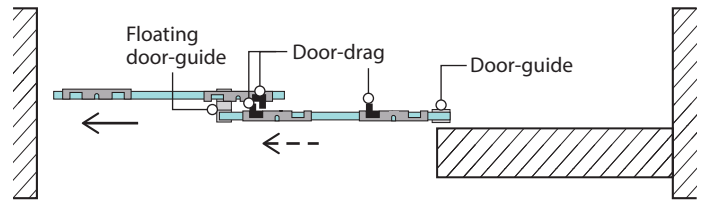

DOOR CLOSING

MODEL	MAX DOOR WEIGHT (kg)	LENGTH OF TRACK (mm)		
2DDT-F-UL80	80	2000	3000	4000
2DDT-F-UL120	120	2000	3000	4000

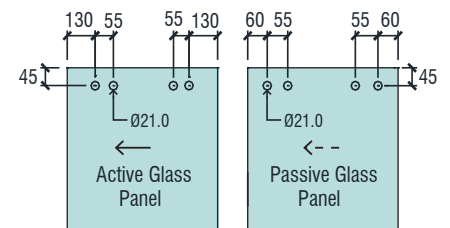

GLASS DOOR AND GLASS CLAMP HOLE DIMENSION

STANDARD ACCESSORIES

<p>Track</p> <p>SLIDEHIDE aluminium track.</p>	<p>Roller & Glass clamp</p> <p>SLIDEHIDE Roller and aluminium Glass clamp comes with Door-drag. Test report is available.</p>	<p>End-stopper</p> <p>SLIDEHIDE End-stopper for positioning and preventing door panel from jumping.</p>	<p>Door-guide</p> <p>SLIDEHIDE Door-guide and Floating door-guide prevents door panel from wobbling while sliding.</p> <p>Floating door-guide</p>
---	--	--	---

SLIDE & HIDE System (S) Pte Ltd

11, Yishun Industrial Street 1, #07-99, North Spring Bizhub. Singapore 768089

Tel: +65 6369 9988

Fax: +65 6369 9977

For Email: enquiry@slidehide.com.sg

For Feedback: cust-svc@slidehide.com.sg

Website: www.slidehide.com.sg

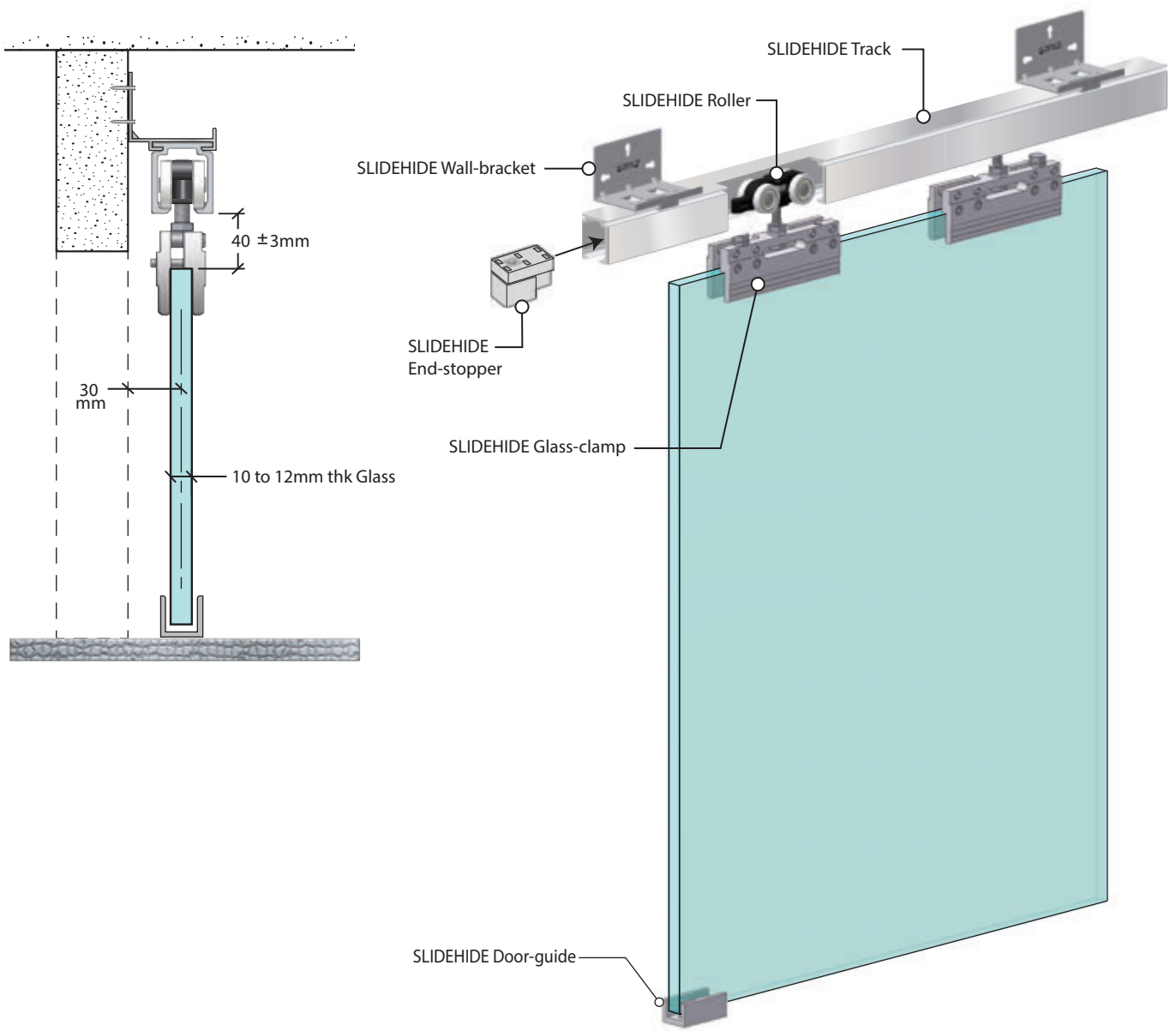

MODEL	MAX DOOR WEIGHT (kg)	LENGTH OF TRACK (mm)		
1D1T-F-WM80	80	2000	3000	4000
1D1T-F-WM120	120	2000	3000	4000

STANDARD ACCESSORIES

Track

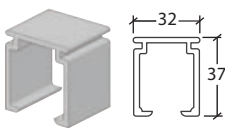

SLIDEHIDE aluminium track.

Roller & Glass clamp

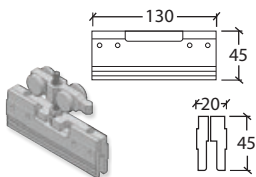

SLIDEHIDE Roller and aluminium Glass clamp. Test report is available.

Wall-bracket

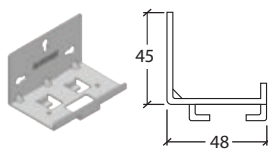

SLIDEHIDE Wall-bracket for mounting track to side of wall.

End-stopper

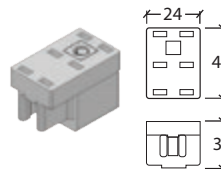

SLIDEHIDE End-stopper for positioning and preventing door panel from jumping.

Door-guide

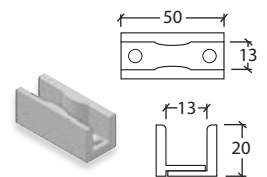

SLIDEHIDE Door-guide prevents door panel from wobbling while sliding.

SLIDE & HIDE System (S) Pte Ltd

11, Yishun Industrial Street 1, #07-99, North Spring Bizhub. Singapore 768089

Tel: +65 6369 9988

Fax: +65 6369 9977

For Email: enquiry@slidehide.com.sg

For Feedback: cust-svc@slidehide.com.sg

Website: www.slidehide.com.sg



LOCATION MAP
SINGAPORE (HEAD OFFICE)

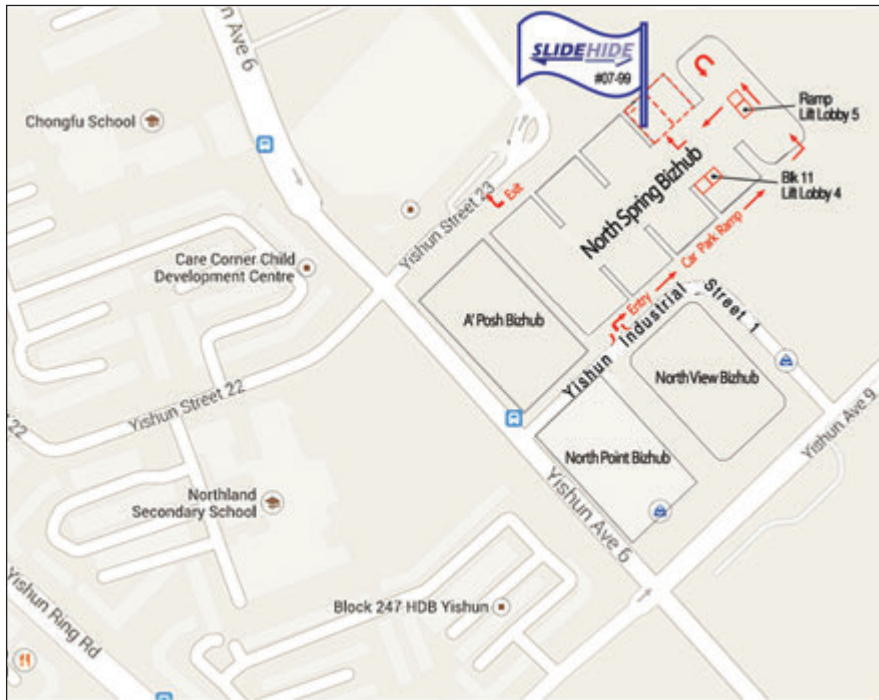

SLIDE & HIDE System (S) Pte Ltd

🏠 Add : 11, Yishun Industrial Street 1, #07-99,
North Spring Bizhub. Singapore 768089
☎ Tel : +65 6369 9988 📠 Fax : +65 6369 9977
✉ Enquiry : enquiry@slidehide.com.sg
✉ Feedback : cust-svc@slidehide.com.sg
🌐 Web : www.slidehide.com.sg



Regional Offices :-

(China)
SLIDE & HIDE System (Suzhou) Co., Ltd (Since 2001)

Branches	Telephone	Fax
Suzhou -	+86 512 6593 0005	+86 512 6593 0006
Shanghai -	+86 21 6233 9866	+86 21 6233 7276
Shenzhen -	+86 755 8363 3199	+86 755 8363 0068

(Malaysia)
SLIDE & HIDE Space Saving System (M) Sdn Bhd (Since 2012)

Tel: +603 7887 8891 Fax: +603 7887 8896

(Philippines)
Wisdom and Wealth Trade, Inc. (Associate Co.)

Tel: +632 668 6698 / +632 507 2680

Fax: +632 277 7832

- Copyright 2015 : SLIDE & HIDE System (S) Pte Ltd. All rights reserved.
- "SLIDEHIDE" is a registered trade mark of SLIDE & HIDE System (S) Pte Ltd.
- The system in this catalogue is protected.
- No part of this catalogue may be reproduced or transmitted in any form or by any means, or stored in any retrieval system of any nature, without prior written permission from SLIDE & HIDE System (S) Pte Ltd.
- The technical presentation and data including illustrations and drawings are not binding. SLIDE & HIDE System (S) Pte Ltd reserves the right to make modifications/ additions/ alterations/ improvements when necessary without prior notification.

DISTRIBUTED BY :-

